



Get known with IG Blinds products



IG Blinds

IG BLINDS MANUFACTURE SUNBELL INTERNAL BLIND SYSTEMS UNDER LICENCE IN AUSTRALIA. SUNBELL MANUFACTURE IN EXCESS OF 90,000 BLINDS ANNUALLY.

EUROPEAN PATENT

DESIGN and QUALITY

SERVICE AND ASSISTANCE

lead times * tutorial

TECHNICAL DEPARTMENT

updated and dynamic

MARKETING

promotion through meetings with manufacturers, designers and architects. Advertising through industry and non-industry channels



Internal blinds:
Design features

DOUBLE GLAZING UNITS

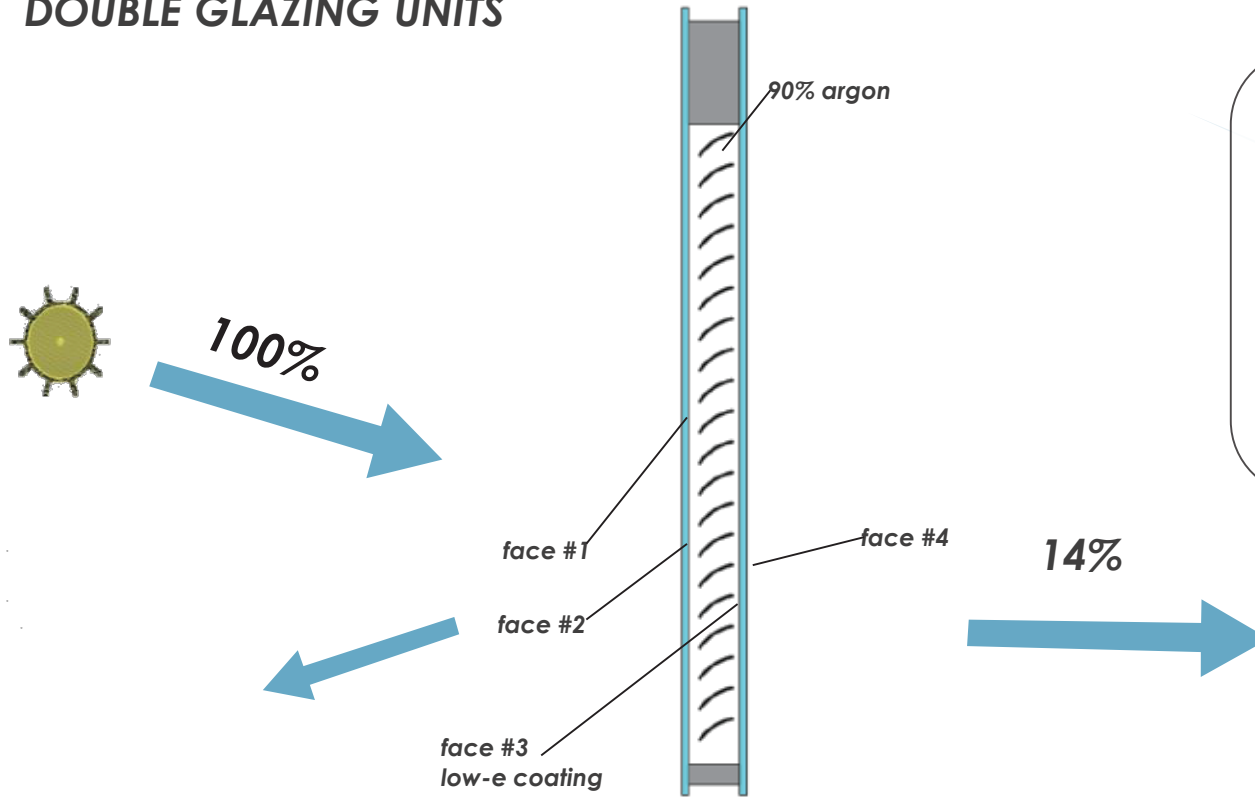

Solution 1:

Glass A: 33,1 Laminated glass, 6,38 mm thickness

Chamber: 22 mm wide, 90% Argon

Internal blind: IG Blinds venetian blind, colour 002

Glass B: 33.1 laminated glass, 6,38 mm thickness, low-e coating on face #3

***g-value = 14% $U_g = 1,1 \text{ W/m}^2\text{°K}$**

(g-value when blind is raised = 60 %)

TRIPLE GLAZING UNITS

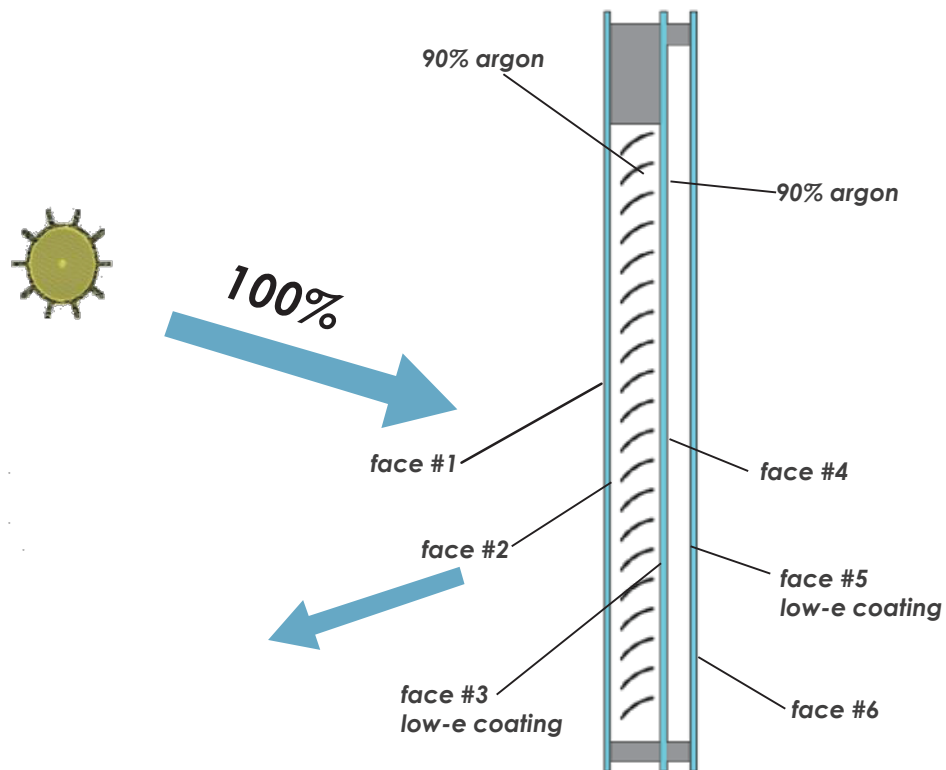

Solution 2:

Glass A: Float, 6mm

Chamber: 22 mm wide, 90% Argon

Internal blind: IG Blinds venetian blind, colour 002

Glass B: 4 mm, **Thermally toughened**, low-e coating on face #3

Chamber: 12 mm wide, 90% Argon

Glass C: 33.1 laminated glass, 6,38 mm thickness, low-e coating on face #5

***g-value = 8%, $U_g = 0,6 \text{ W/m}^2\text{K}$**

Standard solution

TRIPLE GLAZING UNITS

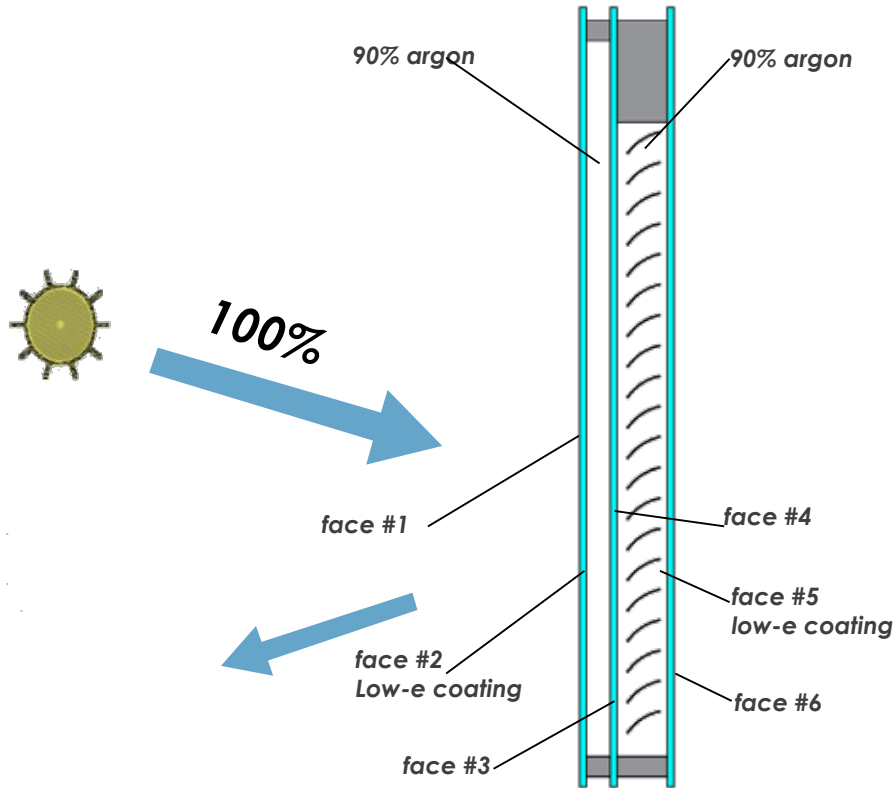

Solution 3:

Glass A: Float, 6mm

Chamber: 12 mm wide, 90 % Argon

Glass B: 4 mm, **Thermally toughened**, low-e coating on face #2

Chamber: 22 mm wide, 90% Argon

Internal blind: IG Blinds venetian blind, colour 002

Glass C: 33.1 laminated glass, 6,38 mm thickness, low-e coating on face #5

***g-value= 8%** **$U_g = 0,6 \text{ W/m}^2\text{°K}$**

Solution for low temperature environments (less than – 10 ° C in the outer chamber)

* G Values/Solar factor

G VALUE (SLATS ANGLE: 53,1°)					
SLATS COLOUR	I.G. UNIT WITH LOW-E COATING	I.G. UNIT WITH SELECTIVE COATING	I.G. UNIT WITH SELECTIVE COATING AND LOW-E COATING	TRIPLE GLAZING WITH SELECTIVE COATING AND LOW-E COATING	TRIPLE GLAZING WITH DOUBLE LOW-E COATINGS
002	0,20	0,14	0,11	0,09	0,12
028	0,20	0,14	0,11	0,08	0,12
029	0,21	0,16	0,12	0,08	0,11
048	0,21	0,15	0,12	0,08	0,11
050	0,20	0,15	0,12	0,08	0,12
051	0,20	0,15	0,11	0,08	0,12
052	0,20	0,15	0,12	0,08	0,11
053	0,20	0,15	0,12	0,08	0,12
056	0,21	0,17	0,13	0,08	0,11
G VALUE (SLATS ANGLE: 75°)					
SLATS COLOUR	I.G. UNIT WITH LOW-E COATING	I.G. UNIT WITH SELECTIVE COATING	I.G. UNIT WITH SELECTIVE COATING AND LOW-E COATING	TRIPLE GLAZING WITH SELECTIVE COATING AND LOW-E COATING	TRIPLE GLAZING WITH DOUBLE LOW-E COATINGS
002	0,12	0,08	0,08	0,06	0,07
028	0,12	0,09	0,09	0,06	0,07
029	0,14	0,11	0,11	0,07	0,08
048	0,13	0,10	0,10	0,07	0,08
050	0,13	0,10	0,10	0,07	0,08
051	0,12	0,09	0,09	0,07	0,08
052	0,13	0,10	0,10	0,07	0,08
053	0,13	0,10	0,10	0,07	0,08
056	0,15	0,13	0,13	0,08	0,09

* European G Values are a measurement of solar heat gain and all Sunbell testing is based on European calculations. SHGC performance data is available on request.

U values

ALUMINIUM WINDOWS	I.G. UNIT WITH LOW-E COATING	I.G. UNIT WITH SELECTIVE COATING	I.G. UNIT WITH SELECTIVE COATING AND LOW-E COATING	TRIPLE GLAZING WITH SELECTIVE COATING AND LOW-E COATING	TRIPLE GLAZING WITH DOUBLE LOW-E COATINGS
THERMAL TRANSMITTANCE OF THE GLASS	$U_g = 1,1 \text{ W/m}^2 \text{ K}$	$U_g = 1,1 \text{ W/m}^2 \text{ K}$	$U_g = 1,1 \text{ W/m}^2 \text{ K}$	$U_g = 0,5 \text{ W/m}^2 \text{ K}$	$U_g = 0,5 \text{ W/m}^2 \text{ K}$
THERMAL TRANSMITTANCE OF THE WINDOW - ALUMINIUM SPACERS	$U_w = 1,5 \text{ W/m}^2 \text{ K}$	$U_w = 1,5 \text{ W/m}^2 \text{ K}$	$U_w = 1,5 \text{ W/m}^2 \text{ K}$	$U_w = 1,0 \text{ W/m}^2 \text{ K}$	$U_w = 1,0 \text{ W/m}^2 \text{ K}$
THERMAL TRANSMITTANCE OF THE WINDOW - MULTITECH SPACERS	$U_w = 1,3 \text{ W/m}^2 \text{ K}$	$U_w = 1,3 \text{ W/m}^2 \text{ K}$	$U_w = 1,3 \text{ W/m}^2 \text{ K}$	$U_w = 0,8 \text{ W/m}^2 \text{ K}$	$U_w = 0,8 \text{ W/m}^2 \text{ K}$
TIMBER WINDOWS	I.G. UNIT WITH LOW-E COATING	I.G. UNIT WITH SELECTIVE COATING	I.G. UNIT WITH SELECTIVE COATING AND LOW-E COATING	TRIPLE GLAZING WITH SELECTIVE COATING AND LOW-E COATING	TRIPLE GLAZING WITH DOUBLE LOW-E COATINGS
THERMAL TRANSMITTANCE OF THE GLASS	$U_g = 1,1 \text{ W/m}^2 \text{ K}$	$U_g = 1,1 \text{ W/m}^2 \text{ K}$	$U_g = 1,1 \text{ W/m}^2 \text{ K}$	$U_g = 0,5 \text{ W/m}^2 \text{ K}$	$U_g = 0,5 \text{ W/m}^2 \text{ K}$
THERMAL TRANSMITTANCE OF THE WINDOW - ALUMINIUM SPACERS	$U_w = 1,4 \text{ W/m}^2 \text{ K}$	$U_w = 1,4 \text{ W/m}^2 \text{ K}$	$U_w = 1,4 \text{ W/m}^2 \text{ K}$	$U_w = 0,8 \text{ W/m}^2 \text{ K}$	$U_w = 0,8 \text{ W/m}^2 \text{ K}$
THERMAL TRANSMITTANCE OF THE WINDOW - MULTITECH SPACERS	$U_w = 1,2 \text{ W/m}^2 \text{ K}$	$U_w = 1,2 \text{ W/m}^2 \text{ K}$	$U_w = 1,2 \text{ W/m}^2 \text{ K}$	$U_w = 0,7 \text{ W/m}^2 \text{ K}$	$U_w = 0,7 \text{ W/m}^2 \text{ K}$
PVC WINDOWS	I.G. UNIT WITH LOW-E COATING	I.G. UNIT WITH SELECTIVE COATING	I.G. UNIT WITH SELECTIVE COATING AND LOW-E COATING	TRIPLE GLAZING WITH SELECTIVE COATING AND LOW-E COATING	TRIPLE GLAZING WITH DOUBLE LOW-E COATINGS
THERMAL TRANSMITTANCE OF THE GLASS	$U_g = 1,1 \text{ W/m}^2 \text{ K}$	$U_g = 1,1 \text{ W/m}^2 \text{ K}$	$U_g = 1,1 \text{ W/m}^2 \text{ K}$	$U_g = 0,5 \text{ W/m}^2 \text{ K}$	$U_g = 0,5 \text{ W/m}^2 \text{ K}$
THERMAL TRANSMITTANCE OF THE WINDOW - ALUMINIUM SPACERS	$U_w = 1,3 \text{ W/m}^2 \text{ K}$	$U_w = 1,3 \text{ W/m}^2 \text{ K}$	$U_w = 1,3 \text{ W/m}^2 \text{ K}$	$U_w = 0,8 \text{ W/m}^2 \text{ K}$	$U_w = 0,8 \text{ W/m}^2 \text{ K}$
THERMAL TRANSMITTANCE OF THE WINDOW - MULTITECH SPACERS	$U_w = 1,2 \text{ W/m}^2 \text{ K}$	$U_w = 1,2 \text{ W/m}^2 \text{ K}$	$U_w = 1,2 \text{ W/m}^2 \text{ K}$	$U_w = 0,7 \text{ W/m}^2 \text{ K}$	$U_w = 0,7 \text{ W/m}^2 \text{ K}$

Processing the IG unit- correct installation

Preparation of the spacer profiles
The profiles come cut to size



1. The upper rail lip (A) must face the outside
2. The side spacer lips face the outside as a standard supply. In case of low-e coating on face 3, side bars are provided with lips protecting face 3 (must be specified when placing the order).

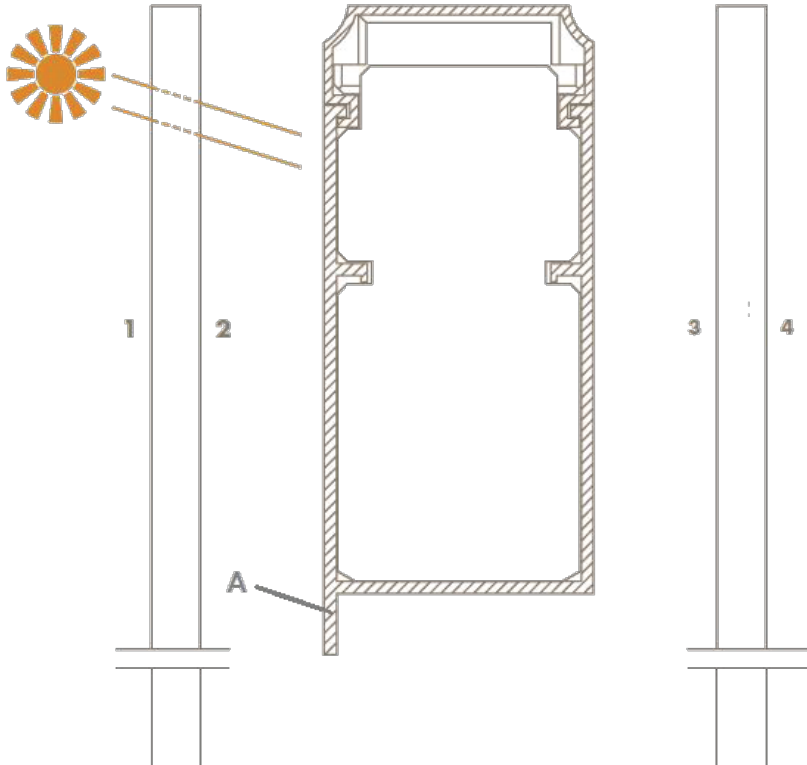

STANDARD UNIT

LOW-E COATING ON FACE 3

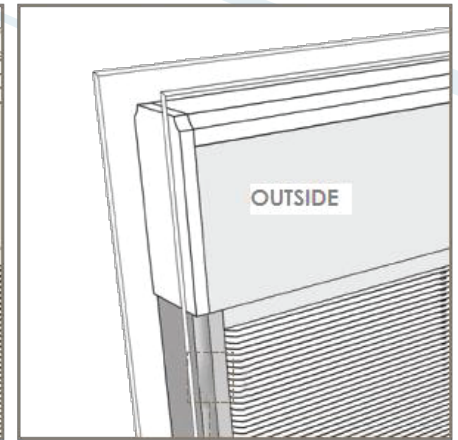
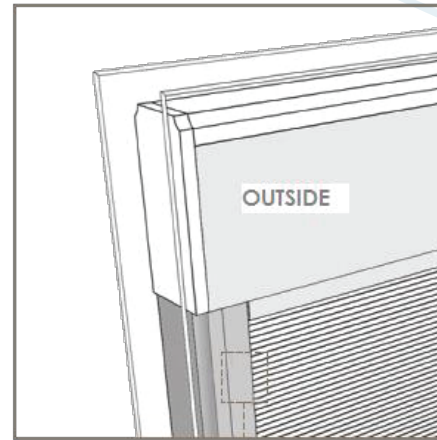

LIP FACING THE OUTSIDE
(FACE 2)

LIP FACING THE INSIDE
(FACE 3)



	Representative glass constructions	Metal with thermal break	Plastic	Wood	Wood/Metal
Representative frame profile					
Representative double-pane glass sheet thermally insulating glass W/m²K	 Double-sheet insulating glass $U_g=1.1 \text{ W/m}^2\text{K}$	0.035	0.031	0.030	0.032
Representative triple-pane glass sheet thermally insulating glass W/m²K	 Triple-sheet insulating glass $U_g=0.7 \text{ W/m}^2\text{K}$	0.030	0.030	0.028	0.030

- PSI values among the best in the category in the world.
- Excellent adhesion to all sealants: PS, PU, Silicone, Hot Melt and Butyl.
- Excellent mechanical stability.
- Possibility to make triple glazing kits by coupling the custom-made Multitech® standard spacers of the same color to the IG Blinds profile
- The plastic material, for which the research of the ALU-PRO / ROLLTECH group is constantly evolving, is by its nature more fragile than metal materials. This aspect does not affect the glazing in any way. Then:
 - More care is required when handling profiles, compared to metal profiles.
 - We recommend a visual inspection of the profiles once received (especially if sent by express courier).
 - In case of breakage it is necessary to inform IG Blinds, who will return the damaged channels. Do not complete the insulating glass with damaged grooves!

IG Manual Blind
KNOB OPERATED, TILTING ONLY BLIND



IG Cord Blind
MANUAL, CORD OPERATED BLIND



IG Auto Blind

HARDWIRED MOTORISED BLIND WITH
CONTROL UNIT



IG All in One Blind

HARDWIRED MOTORISED BLIND WITH
CAPACITIVE CONTROL SYSTEM



IG Remote Blind

BATTERY OPERATED MOTORISED BLIND



IG Blinds: uses and tricks

IG Manual Blind:

*Ideal for public buildings
Tamper-proof system
Great feasibility
Tilting function only
Low cost*

Installation:

*Consider cable and space dimensions
Set the knob and its limits*



Available kits:

*22 mm cavity(aluminum or warm edge) with 15 mm slat
20 mm cavity (warm edge only) with 12.5 mm slat*

IG Blinds: uses and tricks

IG Cord Blind:

Low cost

Completely manual functioning

Control system outside the IG unit

Raising, lowering and tilting function

Installation:

Internal glass thickness max 10mm monolithic

Tilting only version available

Extra care for the external control system
installation



IG Cord Blind 2018 – improvement study

Improved magnetic features

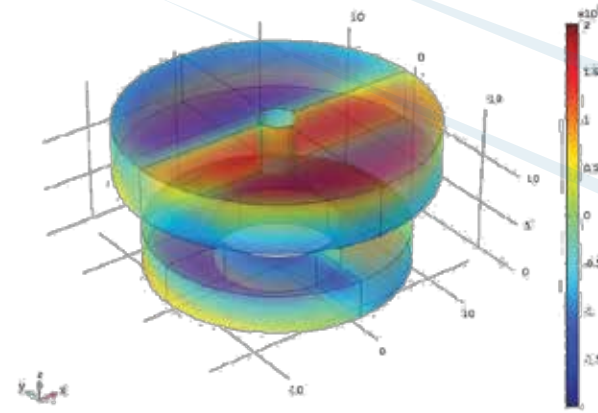
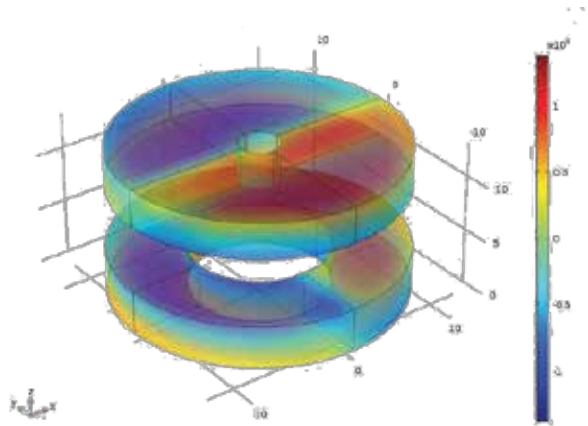

Φ25 x Φ12 x Th3,8 mm Φ24,8 x Φ3,6 x Th3,3 mm	Airgap [mm]	Forza	Coppia
		[N]	[mN°m]
REN 35 H	6	10,32	41,87
	10	5,56	19,64

Φ25 x Φ12 x Th3,8 mm Φ30 x Φ3,6 x Th5 mm	Airgap [mm]	Forza	Coppia
		[N]	[mN°m]
REN 35 H	6	17,79	94,97
	10	11,82	63,92
REN 45 H	6	22,26	118,84
	10	14,80	79,98

IG Remote Blind - BATTERY SYSTEM – STRENGTHS

Ideal application for home renovations where it is necessary to replace doors and windows without wiring installation.

- ✓ No hardwiring needed
- ✓ European patent: the electronics are entirely contained in the actuator, for best reliability and durability
- ✓ Lithium-polymer battery: recharging via micro-USB cable.
- ✓ Optionals: photovoltaic solar panel and remote control
- ✓ 2 cm thickness of the actuator: ideal for sliding doors
- ✓ Greatest feasibility on the market
- ✓ Compatible with all previous battery-operated IG Blinds



Wire extension

This extension guarantees perfect installation, both for window manufacturers and for glass processors.

Avoids wrong managing of the unit by the windowmaker.

The risk of pin damages will also be reduced.

The correct IG unit process includes:

1. Assembly of the insulating glass with the cap (A) inserted.
2. Proper drying of the sealants (at least 48 hours).
3. Carving the sealant with proper tools and removing the (A) cap.
4. Inserting the wire extension.
5. Sealing with proper IG unit sealant.

IMPORTANT:

In case of damaged power wiring, the extension makes it easier to replace it.

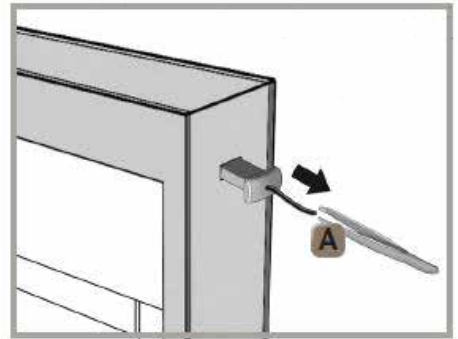

STANDARD IG Remote Blind CONNECTOR APPLICATION

ATTACHING THE MAGNETIC CONNECTOR

Page 3

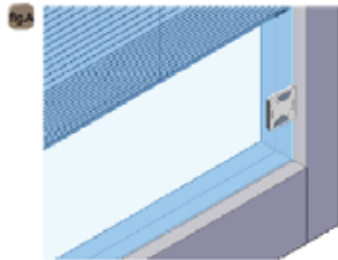

APPLICATION ON THE GLASS:

The glass has to be clean and dry.
The application needs to be done at a temperature of 20°C.
If the environmental temperature is very low, heat up the glass surface until reaching 20°C.
Remove the backing from the connector and apply firm pressure.
Firm bonding will be achieved within 72 hours.

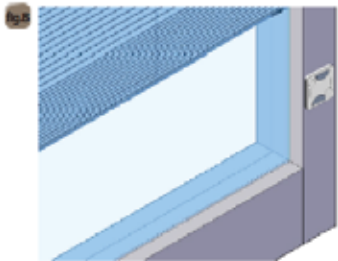

APPLICATION ON THE FRAME:

Drill an 8 mm diameter hole and insert the cable. Remove the plug by pressing the back of the connector to create space for the screw.

CONNECTOR DIMENSIONS (mm)

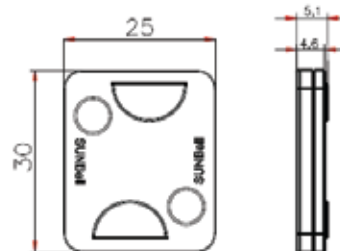

SOLAR PANEL IG Remote Blind CONNECTOR APPLICATION EXTERNAL PANEL

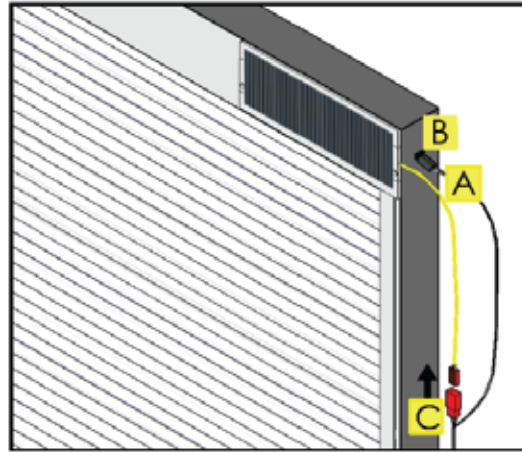

Plug the black connector **A** in the correct position **B**.
Plug the red connector in the correct position **C**.

Test the correct functioning of the blind as shown in the video, then seal the lid with some IG unit silicone.

DIMENSIONS OF THE EXTERNAL SOLAR PANEL

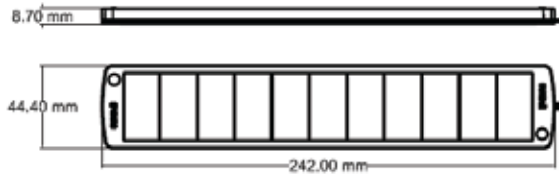

CABLE WITH CONNECTORS



CABLE LENGTH, PLEATED/DUETTE/VENETIAN BLIND:

Blind height	Command cable length
up to 1200 mm	1000 mm
1201 - 2000 mm	1500 mm
2001 - 3000 mm	2000 mm

SOLAR PANEL IG Remote Blind CONNECTOR APPLICATION INTERNAL PANEL

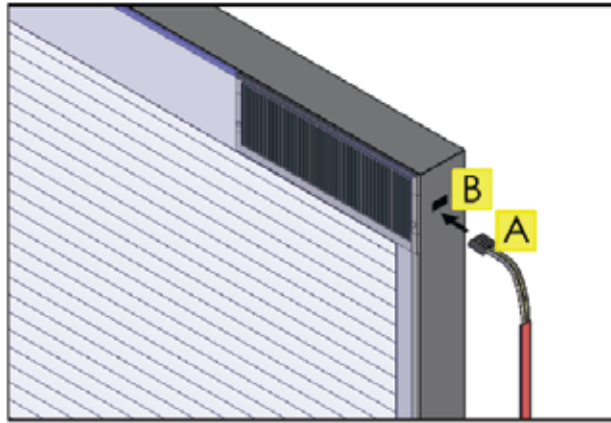

Plug the connector **A** in the correct position **B**.

Test the correct functioning of the blind as shown in the video, then seal the lid with some IG unit silicone.



CABLE WITH CONNECTOR

CABLE LENGTH, PLEATED/DUETTE/VENETIAN BLIND:

Blind height	Command cable length
up to 1200 mm	1000 mm
1201 - 2000 mm	1500 mm
2001 - 3000 mm	2000 mm

IG Auto Blind system strengths

Ideal application for new buildings, luxury homes and non, hotels, complete homes renovation that also involves the renovation of electrical network.

- *The blinds can be controlled by a wall switch or by remote control*
- *Compatible with home automation systems*
- *Maximum aesthetic result*
- *Electronics out of the glazing: great durability and reliability*
- *Greatest feasibility on the market.*

APPLICABLE MAXIMUM DISTANCES AND WIRE SECTIONS

SIZE, DIMENSIONS AND MAXIMUM DISTANCES

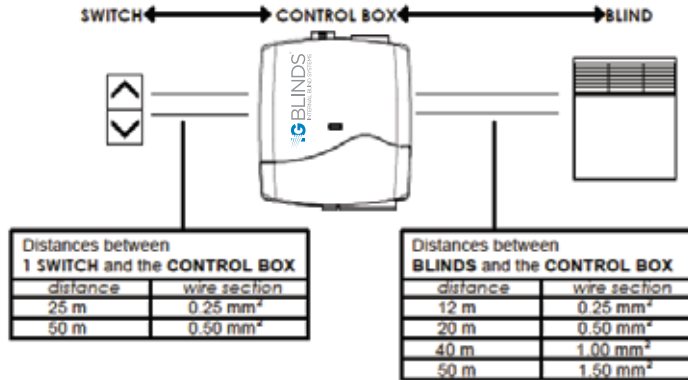

N.B.: STANDARD CABLE LENGTH 2000 mm

CONTROL BOX DIMENSIONS

132mmx115mmx49mm

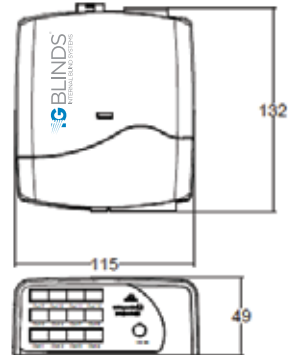

POWER SUPPLY DIMENSIONS

- L 156 mm x P 68 mm x H 40 mm (10-12 channels)
- L 128 mm x P 52 mm x H 32 mm (6-8 channels)
- L 108 mm x P 47 mm x H 29 mm (4 channels)
- L 96 mm x P 45 mm x H 31 mm (2 channels)



ELECTRIC CONTACT CONNECTORS

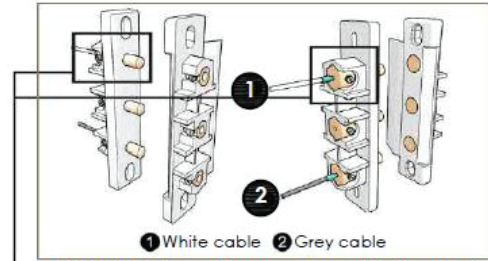

WARNING: do not tamper or modify the plastic wings. **Danger of short circuit!**

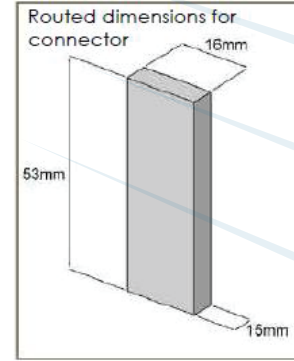

FIXING CABLES TO CONNECTOR

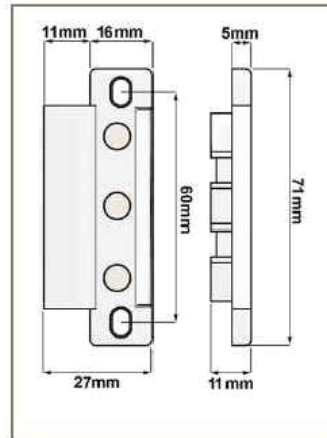
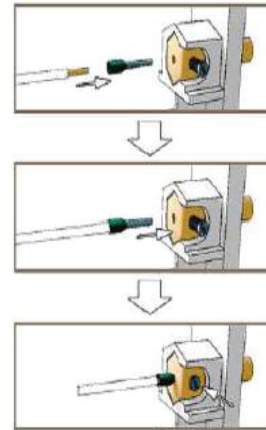

Located on the frame

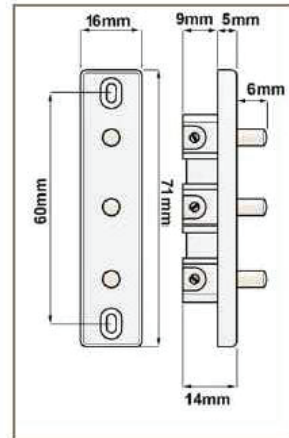

Located on the hinged side

DOOR LOOP

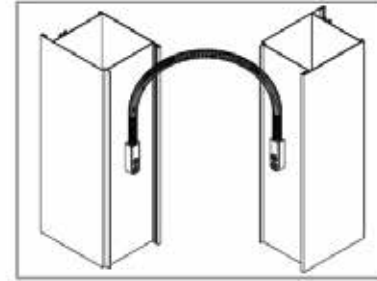

The miniature door loop M 12 80 can be used to hide cables in windows and doors. Installation in the fold area is possible almost everywhere due to the small space requirement. The unsightly installation of open door loops or the expensive installation of customary concealed door loops is therefore not required. Ideal for alarm glass cables or glass breaking alarms.

Pivot/hopper windows retain their full functionality

Door loop is accessible only on opening the window or door.

Low installation expenditure

Suitable for round cable and flat cable (e.g., for alarm glass)

Inner diameter: 5.3 mm

Important note: Due to the large number of profiles available in the market, it is impossible to make universal specifications about the installation location. As the profiles differ in design as well as dimensions, we hereby provide notes on the design and installation. Please leave a cable loop. This will ensure that adequate cable is available for sliding on opening the door

REMOTE CONTROL

- Hi-tech, thin design to match with IG Remote Blind actuators;
- Blinds control: individual, general, multiple selections;
- Compatible systems: IG Remote Blind, IG Auto Blind, IG All in One Blind;
- Rechargeable lithium-polymer battery for longer life;
- Charging via micro-USB port;
- 4000 possible combinations to avoid interferences.

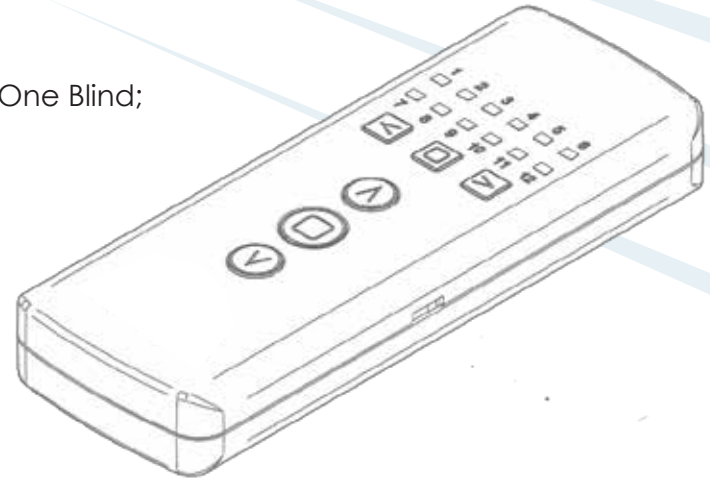

IG ALL IN ONE BLIND SYSTEM

*Physical keys are replaced by capacitive, touch sensitive devices.
Out of the glass electronics.
12 V power supply.
Available for 20,22,27 mm cavities, warm edge and aluminum spacers.
Optional: remote control.
Group function available through remote control.
Control device thickness: 9 mm.
Installation: glass or window.*

ATTENTION:

- *Electrical system and a power supply required.*
- *Not suitable for home automation systems.*
- *Wall switch not available*



REMOTE CONTROL – IG ALL IN ONE BLIND SYSTEM

- a) Keep pressed the up and down commands on the device at the same time for 10 seconds, till the alternate flashing of the blue LEDs.
- b) Within 25 seconds, turn the remote control on, select the channel you want to assign to the blind, then press button **2** or **3**.
- c) A 5 seconds alternate slow flashing of the blue LEDs on the device will confirm the correct setting.

Repeat the procedure with each device/blind.

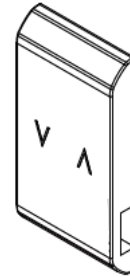

"ALL IN ONE"
DEVICE

- N.B.:**
- A new setting on the same channel of the remote control deletes the previous one.
 - It is possible to assign more than one blind to the same channel, moving multiple blinds simultaneously.

IG ALL IN ONE BLIND SYSTEM

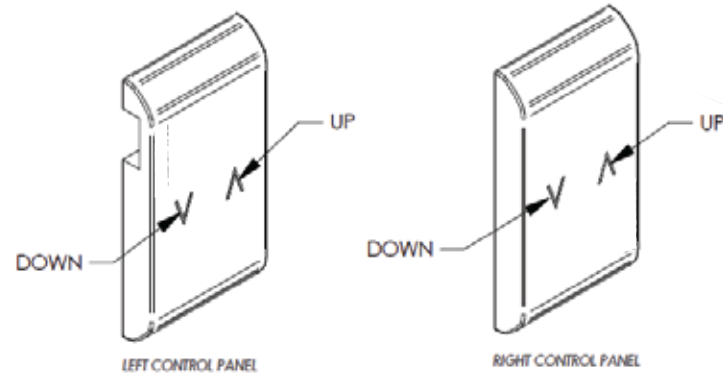

Raising, lowering and tilting the blind

The blind is controlled through capacitive sensors in the "ALL IN ONE" control panel.

Touch once the "UP" or "DOWN" symbol to raise or lower the blind (automatic mode).

To change direction of the blind's movement stop it by touching the "UP" or "DOWN" symbol, then touch the "UP" or "DOWN" symbol once more.

Touch and hold the "UP" or "DOWN" symbol to raise or lower the blinds in slow mode.

Touch and hold the symbol opposite to the last one touched to tilt the slats (function not available with fabric blinds).

The lit blue LED and the movement of the blinds indicate proper functioning of the blind.

WIRING

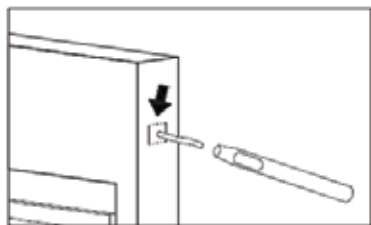

1. Carve the sealant around the cap with a cutter.

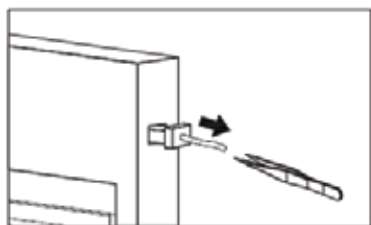

2. Remove the cap pulling the thread with tweezers.

3. Test the correct functioning of the blind with IG Blinds test kit.

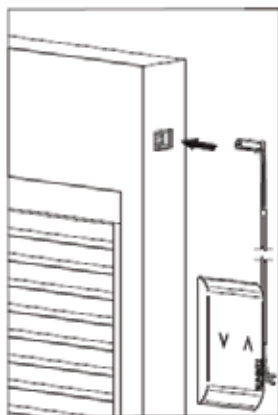

4. Insert the connector in the correct position.

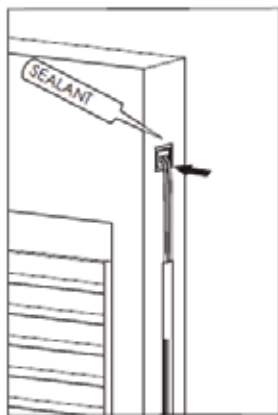

5. Seal the lid with IG unit sealant.

IG ALL IN ONE BLIND SYSTEM

INSTALLING THE CONTROL PANEL ON THE GLASS

1. The glass has to be clean and dry.
2. If the environmental temperature is very low, heat up the glass surface until reaching 20°C. Remove the backing from the control panel and apply firm pressure.
3. Connect the wires to the electrical contact connectors (as shown in page 4).

LEFT HANDED CONTROL

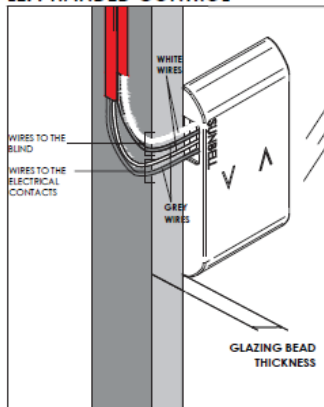

RIGHT HANDED CONTROL

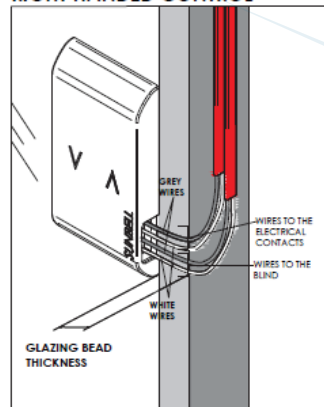

INSTALLING THE CONTROL PANEL ON THE FRAME

1. If it is necessary to drill some holes onto the frame in order to make space for the wires.

DIMENSIONS :

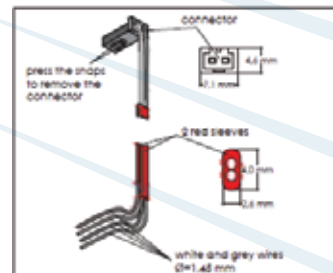

If needed it is possible to remove the connector in order to let the wires pass through the holes: press the snaps on the lower side of the connector to remove it. Then put back the wires in the original position.

2. Insert the side cap before sticking the control panel onto the frame.

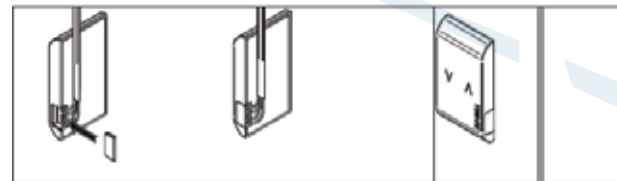

3. The surface of the frame must be clean and dry.
4. Stick the control panel on the frame, by using the biadhesive provided.
5. Connect the wires (as shown in page 4).

IG ALL IN ONE BLIND SYSTEM

ELECTRICAL WIRING DIAGRAM

- It is possible to install both single blinds and groups of blinds (up to 12 blinds per group). Each group need one power supply.
- Blinds input: 12V DC.
- Maximum electrical absorption for each blind: 1A.
- Maximum distance between power supply and each blind: 50m.

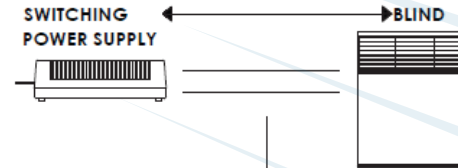
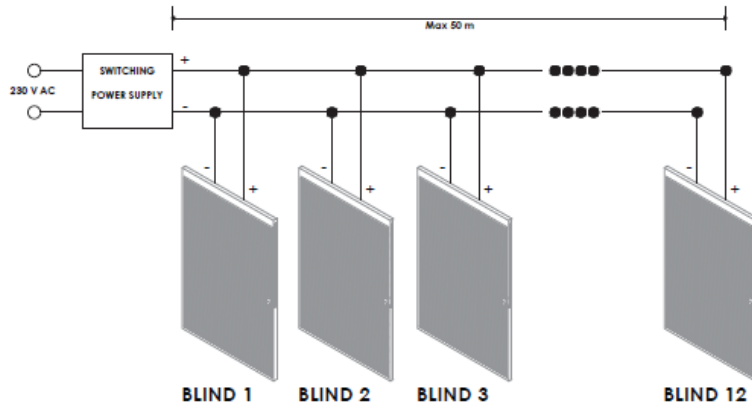

Maximum distances between power supply and blinds

distance	wire section
12 m	0.25 mm ²
20 m	0.50 mm ²
40 m	1.00 mm ²
50 m	1.50 mm ²

POWER SUPPLY DIMENSIONS

- L 156 mm x P 68 mm x H 40 mm (12 blinds)
- L 128 mm x P 52 mm x H 32 mm (8 blinds)
- L 108 mm x P 47 mm x H 29 mm (4 blinds)
- L 96 mm x P 45 mm x H 31 mm (2 blinds)

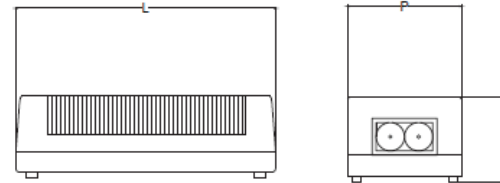

TESTING KIT

CAUTION:

Before installation test every blinds with IG Blinds Testing kit.



Tips to perform the test correctly:

Use **only** IG Blinds testing kit.

Test the blinds perpendicularly to the floor.

Ignoring these instructions may result in breakage or malfunction of the blind, and causes void of warranty.

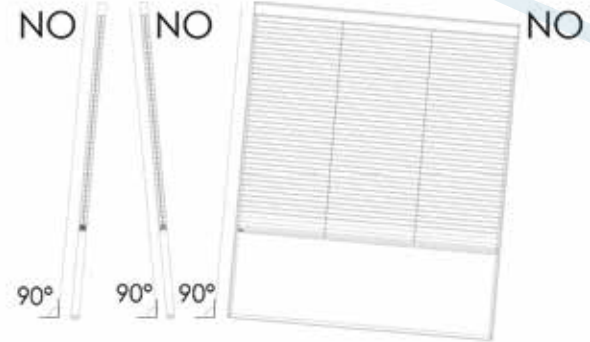

TRANSPORTATION

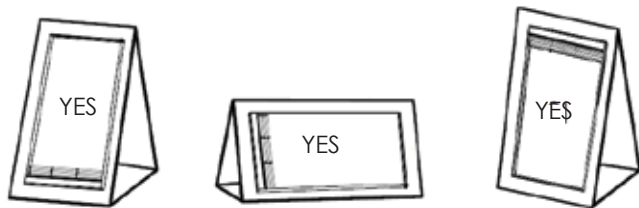

Before transportation, it is necessary to protect the IG unit in order to isolate them from the elements and take all precautions to prevent damages.

During transportation raise the blinds completely as shown in the pictures.

Particular attention must be paid to the transportation to places with altitude and climatic conditions different from the place of manufacture: possible deflection of the glass pane.

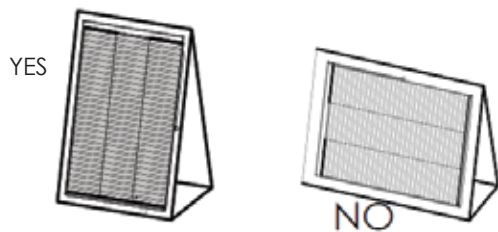

BLINDS WITH TILTING FUNCTION ONLY

it is necessary to avoid the overturning of the slats, the interlocking of slats between the glass sheets and the spacer and the compromising of the degree of slats closing.

Transport with slats in horizontal position

DISPLAY UNIT

You will receive:

- 1 IG Remote Blind sample (solar panel optional)
- 1 IG Manual Blind or IG Cord Blind sample
- 1 LCD monitor with videos uploaded
- Advertising material (catalogues, colour swatches)

Fairs and exhibitions

GA18 Conference

29–31 August
Gold Coast, Australia















INGO PROGETTO

14 workshops in Italy

Architect @ Work

17-18 October- Roma
14-15 November- Milano

Fensterbau - Nurnberg
Glasstec - Dusseldorf
Batimat - Moscow

		CONTROL SYSTEMS				
		IG Remote Blind 	IG Auto Blind 	IG Cord Blind 	IG ALL IN ONE Blind 	IG Manual Blind 
SHADING SOLUTION	VENETIAN 20 MM 	OK	OK	OK	OK	WARM EDGE ONLY OK
	VENETIAN 22 MM 	WARM EDGE AVAILABLE OK	WARM EDGE AVAILABLE OK	WARM EDGE AVAILABLE OK	WARM EDGE AVAILABLE OK	WARM EDGE AVAILABLE OK
	VENETIAN 27 MM 	WARM EDGE AVAILABLE OK	WARM EDGE AVAILABLE OK		WARM EDGE AVAILABLE OK	
	SUNBLOCK 27 MM 	WARM EDGE AVAILABLE OK	WARM EDGE AVAILABLE OK		WARM EDGE AVAILABLE OK	
	SUNVEIL 27 MM 	WARM EDGE AVAILABLE OK	WARM EDGE AVAILABLE OK		WARM EDGE AVAILABLE OK	
	PLEATED 22 MM 	WARM EDGE AVAILABLE OK	WARM EDGE AVAILABLE OK	WARM EDGE AVAILABLE OK	WARM EDGE AVAILABLE OK	
	PLEATED 27 MM 	WARM EDGE AVAILABLE OK	WARM EDGE AVAILABLE OK		WARM EDGE AVAILABLE OK	
	HARDWIRING 		OK		OK	
	REMOTE CONTROL 	OK	OK		OK	
	SOLAR PANEL 	OK				



IG Blinds Case Study – Frankston Hospital

IG Blinds, manufactured in Australia by Australian Insulated Glass (AIG), have been installed with the recent upgrade to the Frankston Hospital's Psychiatric Assessment and Planning Unit (PAPU) – and to significant acclaim. The window system was installed by Victorian company All Points Glass and Aluminium – the PAPU facility is just one of the mental health services available at Frankston Hospital.

IG Blinds, house quality European venetian blinds in the cavity (Intersital) of a double glazed unit, and are permanently kept secure and dust-free within the IGU – the option also exists for them to be triple glazed if required.

Trudi McGauley, Senior Estimator with All Points Glass and Aluminium, explains this product's multiple advantages in a hospital setting. 'Jockey sashes have been commonly used in hospitals in the past, but these are no longer needed with products such as IG Blinds,' she says. 'The anti-ligature design is critical in a mental health facility, as it prevents patients from self-harm and allowing for natural light entering the hospital room to be adjusted to meet each patients individual preference.'

Responding to the brief also presented design challenges. 'For patient safety, the units required 11.52 Super Clear Toughened PolySecure Laminate on each facing,' Trudi points out. 'The fully remote control function is enabled by a powerful motor to operate the Intersital blinds, and we needed to ensure the mechanism would operate efficiently through the customised safety glazing system. Standard intersital blinds can be manufactured with or without laminated glass and use a battery operated remote.'



Sourcing materials to withstand high-impact was an important consideration. 'As some of the Adult Mental Health Units can require PolySecure or a similar speciality Toughened Laminated Glass with Intersitural Blinds, the Capral 150 with 50mm pockets was one of the few systems with sufficient dimensions for these units to be glazed into,' Trudi explains.

Another important feature with IG Blinds is improved hygiene. Unlike regular blinds or window furnishings, glass does not harbour bacteria or hospital bugs, with the IG Blinds contributing to a healthier environment for all patients, staff and visitors to the hospital.

IG Blinds' design and superior thermal performance lowers energy costs, greatly improves patient comfort, and the glass specified by All Points Glass allows for increased transparency and natural daylight to enter each patients room. If external noise is of concern, or increased thermal performance is required, specifying the correct glazing system to address both of these issues can also be incorporated into IG Blinds.

Trudi couldn't be happier with her supplier. 'Phil French of AIG delivered complete custom-laminated units from Queensland to Melbourne in three to four weeks, as opposed to the timeframe of up to 12 weeks offered by other suppliers. This is even more impressive than it sounds, given that the motors had to be imported from Italy, then combined with the mechanisms and laminates which were custom-made in Australia.'

Patient safety, comfort and improved energy efficiency were on top of the brief with the Peninsula Health Frankston Hospital upgrade, now recognised as an innovative and world-leading medical facility.



THANK YOU